

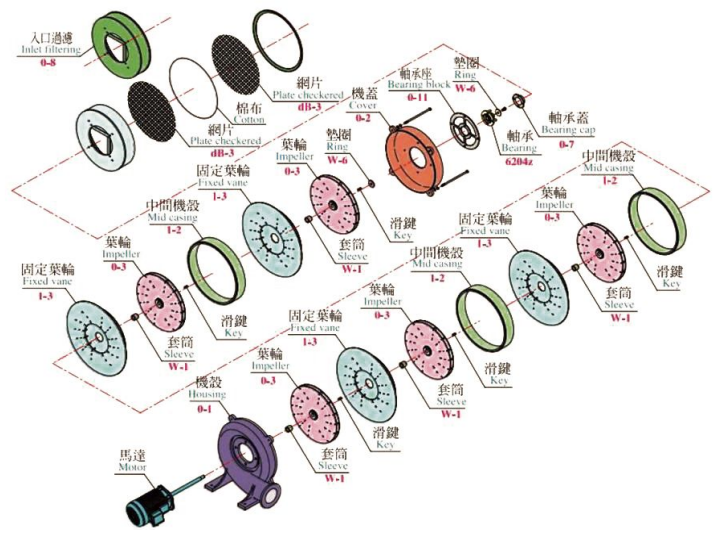

# HTB75-104

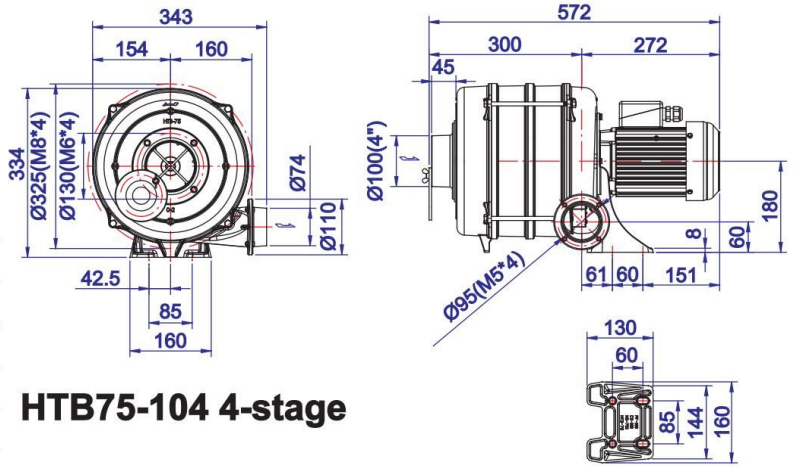
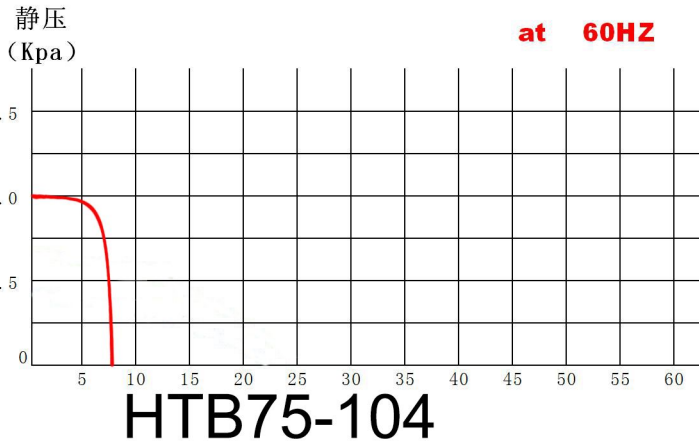
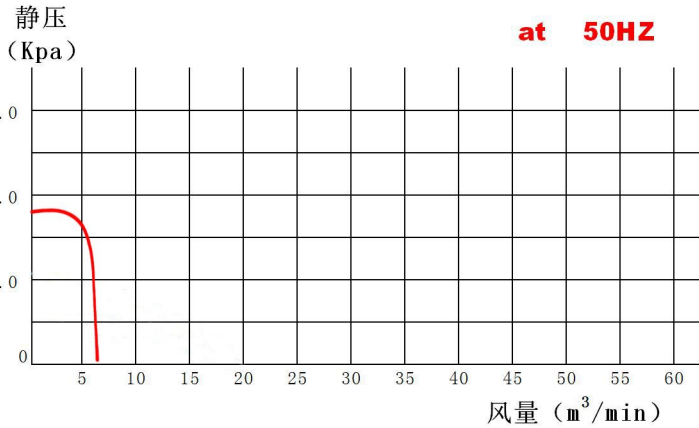

## HTB SERIES SPECIFICATION SHEET

风机型号 Type	相数 Phase	功率 Power (KW)	额定电压 Voltage (V)	额定电流 Current (A)	最大静压 (吐出) Vacuum/Pressure (max) (KPa)	最大风量 (吐出) Air Flow (max) (m <sup>3</sup> /min)	出入口 口径 In/Out (mm)	噪音 Noise Level (dB)	重量 Weight (Kg)
HTB75-032	3 ~	0.4	220 / 380	1.9/1.2	2.1/2.6	6/7	75	53/65	17
HTB75-053	3 ~	0.4	220 / 380	1.9/1.2	2.9/3.8	6.5/7.5	75	55/68	19
HTB75-104	3 ~	0.75	220 / 380	3/2.0	3.7/5	6.5/8	75	56/70	24
HTB75-105	3 ~	0.75	220 / 380	3/2.0	4.2/6	6.8/8.5	75	56/70	28
HTB100-102	3 ~	0.75	220 / 380	3/2.0	3.4/4.5	11/13	100	60/74	24
HTB100-203	3 ~	1.5	220 / 380	5.5/3.5	5/7	11/14	100	61/76	36
HTB100-304	3 ~	2.2	220 / 380	8/5	6.5/9	12.5/16	100	63/78	42
HTB100-505	3 ~	3.7	220 / 380	13/7.5	7.9/11	12.8/16.5	100	64/80	56
HTB125-503	3 ~	3.7	220 / 380	13/7.5	5.8/7.9	19/23	125	70/85	57
HTB125-704	3 ~	5.5	220 / 380	19/11.5	7.5/10.5	20/24	125	70/88	81
HTB125-1005	3 ~	7.5	220 / 380	26/15.5	9/13	20/24	125	72/90	98

Manvac HTB whole series outlet direction Can rotate in all 360° eight directions, And the left and right directions of the motor can be adjusted. The highly customized service has won us many praises, but Manvac will continue to provide customers with more personalized customized products.